



**Flammable, toxic and
Oxygen gas detector for
industrial applications**

Sensepoint XCD



One-Stop Shop

- Flammable (catalytic or infrared), toxic and Oxygen versions available
- New and retrofit applications
- Suitable for indoor or outdoor use
- Stainless steel or aluminium explosion-proof housing options
- IP66 as standard

Proven and Reliable Sensor Technology

- Surecell™ electrochemical sensors
- Poison immune infrared sensors
- Poison resistant catalytic bead sensors
- Long life sensors

Global Approvals

- European, US, Canadian and Asian
- Compliant with ATEX, IECEx, UL, cUL, KTL, PA, GB and CCCF standards

Easy to Use

- User friendly and intuitive tri-colour backlit display with digits, bar graph and icons
- Fully configurable via magnetic switches
- Optional remote sensor mounting*
- Selectable sink or source 4-20mA output
- Auto-inhibit during maintenance
- MODBUS communications for remote diagnostics/configuration*

Cost Effective

- Common transmitter platform
- Minimal training required
- Reduced spares
- Non-intrusive, one-man operation
- Plug-in sensor replacement
- MODBUS multi drop option offers cabling savings*

Simple Installation

- Plug-in display module removes to give access to terminal area
- Integral mounting bracket
- 2 x M20 or 3/4" NPT cable/conduit entries (certification dependent)
- Removable plug/socket type terminal blocks for ease of wiring
- Sink/source switch to suit preferred wiring topology

Range of Optional Accessories

- Remote sensor mounting kit*
- Remote sensor gassing kit
- Duct mounting kit
- Calibration gas flow housing
- Collecting cone

*Contact Honeywell Analytics for availability of these options.

The Sensepoint XCD range provides comprehensive monitoring of flammable, toxic and Oxygen gas hazards in potentially explosive atmospheres, both indoors and outdoors. Users can modify detector operation using the LCD and magnet switches without ever needing to open the unit. This enables one-man, non-intrusive operation and reduces routine maintenance time and costs.

A tri-colour backlit LCD clearly indicates the unit's status at a glance, even from a distance. A steady green backlight indicates normal operation, flashing yellow indicates fault and flashing red indicates an alarm.

All detectors are supplied pre-configured and include 2 programmable alarm relays, 1 programmable fault relay as well as an industry standard 4-20mA output (sink or source selectable) and MODBUS*.

The scale, range, relay operation, alarm set point and electronic tag number of the detector can be adjusted using the transmitter's LCD and non-intrusive magnetic switches. Outputs are automatically inhibited during adjustment, thereby reducing the risk of false alarm at the control panel during maintenance.

Sensepoint XCD has an integral mounting plate for surface mounting or can be mounted to a horizontal or vertical pipe using the optional pipe mounting bracket. Electrical installation can be made using either conduit or cable with suitable mechanical protection. Two M20 or 3/4" NPT entries are provided (depending on certification). A weatherproof cap is also included for use in the harshest outdoor conditions. Other optional accessories include a sunshade/deluge protection, duct mounting kit, collecting cone and remote mounting sensor socket*.

Sensepoint XCD ensures easy installation and the fastest routine operation by removing the need for hot work permits in hazardous areas. Using easy to replace plug-in sensors, downtime is also reduced and on-going costs are minimised through the use of poison resistant flammable sensors, poison immune infrared Hydrocarbon sensors and patented Surecell™ toxic sensors.



Typical Applications

- Industrial manufacturing facilities
- Power plants
- Waste water facilities
- Utilities
- Food and beverage production
- Refineries and chemical plants
- Onshore oil and gas terminals
- Production platforms
- Exploration and drilling

Sensepoint XCD Overview



There are three different types of the XCD transmitter for use with three different families of sensors.

The mV type transmitter is for use with the mV family of XCD sensors including catalytic sensors to detect flammable gases in the range 0-100%LEL and infrared (IR) sensors for detection of Hydrocarbon gases in the range 0-100%LEL and 0-100%Vol*, as well as Carbon Dioxide (CO₂) in the range 0-2%Vol.

The EC type transmitter is for use with the EC family of XCD sensors including Carbon Monoxide (CO), Hydrogen Sulphide (H₂S) and Hydrogen (H₂).

The Oxygen transmitter is for use with the Oxygen (O₂) XCD sensors.

A transmitter can auto-recognise any sensor from within its sensor family. The sensor simply plugs into the bottom of the transmitter and the transmitter automatically configures itself accordingly.

Sensepoint XCD Sensor Families, Gases and Ranges								
	Gas	User Selectable Full Scale Range	Default Range	Steps	Selectable Cal Gas Range	Default Cal Point		
Sensor Family	Catalytic Bead Sensors							
	mV	Flammable 1 to 8*	20 to 100%LEL	100%LEL	10%LEL	30 to 70% of selected full scale range	50%LEL	
		Infrared Sensors						
		Methane	20 to 100%LEL	100%LEL	10%LEL		50%LEL	
	Methane	20 to 100%Vol.*	100%Vol.	10%Vol.	50%Vol.			
	Carbon Dioxide	2.00%Vol. only	2.00%Vol.	n/a	1.00%Vol.			
	Electrochemical Sensors							
EC	Hydrogen Sulphide	10.0 to 100.0ppm	50.0ppm	0.1ppm	25ppm			
	Carbon Monoxide	100 to 1,000ppm	300ppm	100ppm	100ppm			
	Hydrogen	1,000ppm only	1,000ppm	n/a	500ppm			
O ₂	Oxygen	25.0%Vol. only	25.0%Vol.	n/a	20.9%Vol. (Fixed)	20.9%Vol.		

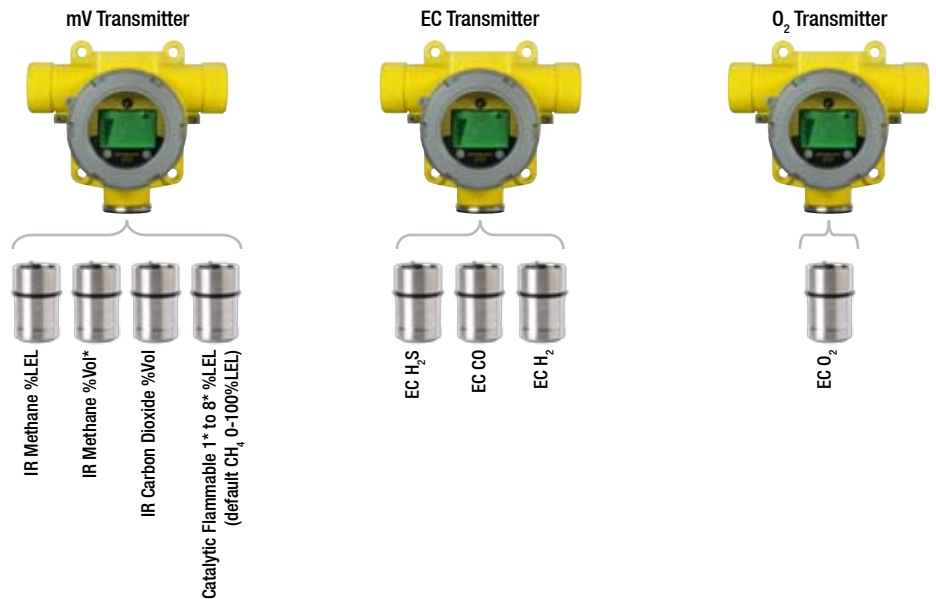

Ready, Steady, Go!

Sensepoint XCD uses three instantly recognisable 'traffic light' colours to indicate its status. The large tri-colour backlit LCD is steady green to indicate normal operation, flashes yellow to indicate a fault/warning and flashes red to indicate an alarm. This allows anyone in the area to clearly see at a glance the status of any detector. This can be particularly useful to identify detector status if the detector is located in a difficult to access area or if a number of detectors are located in the same area.



Installation



Outline Installation Dimensions

The Sensepoint XCD transmitter has an integral mounting plate consisting of four mounting holes on the transmitter body. The transmitter may be fixed directly to a surface mounting, or to a horizontal or vertical pipe/structure, 40.0-80.0mm (1.6 to 3.1") in diameter/cross section. The pipe mounting bracket accessory (optional) may be used for this purpose.

User cable entries shown (2 x M20) are for ATEX/IECEx version enclosures. UL/cUL versions have 2 x 3/4"NPT conduit entries. A suitable blanking plug is supplied which must be used to seal any unused entry. The blanking plug must be suitably sealed to maintain the IP rating of the detector.

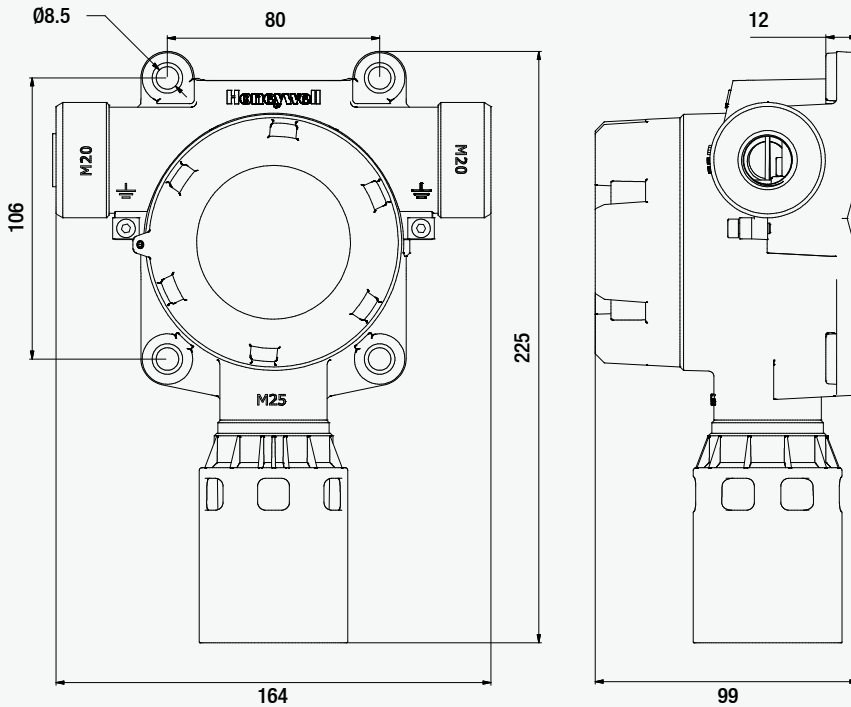

All dimensions in mm.
1" = 25.4mm

Installation Options

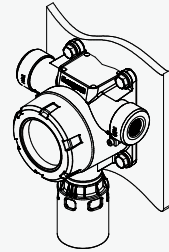

Wall Mounted

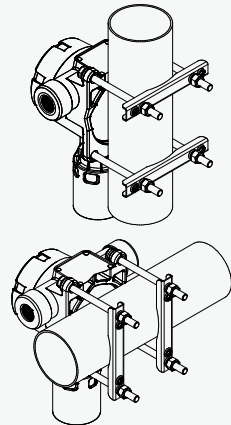

Vertical or horizontal pipe mounted
(Using optional pipe mounting bracket)

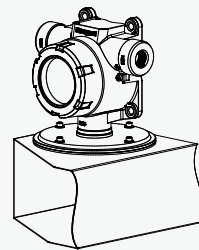

Duct Mounted

Other Accessories

Various accessories are available for different applications:

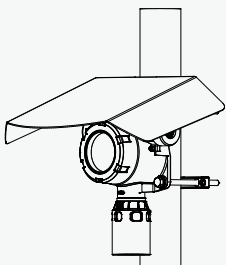

Sunshade/Deluge protection

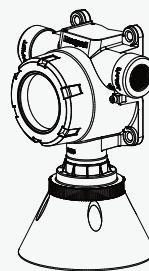
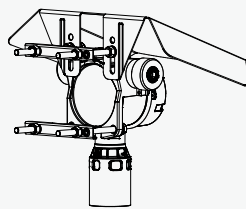

Collecting Cone

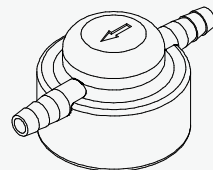

Gassing Cap

Installation



Electrical

Sensepoint XCD is designed for use in potentially explosive atmospheres. As such, installation should follow national guidelines using suitable mechanically protected cable and glands or conduit. Use 0.5mm² (20AWG) to 2.5mm² (~13AWG) cross sectional area cable as needed to ensure minimum operating voltage at the detector, depending on installed cable length. Cable diameter should be selected to maintain the minimum required voltage for the longest installed cable length under maximum power.

Terminal Module Connections

Terminal Number	Marking	Connection	Description
1	24V	+VE Supply (16 - 32VDC)	Controller Connections
2	0V	-VE Supply (OVDC)	
3	4~20mA	Current Output Signal	
4	COM	Drain	MODBUS RTU. RS485 (Pending)
5	TxD	MODBUS B (+)	
6	RxD	MODBUS A (-)	
7	RLY1/NC	Normally Closed	Programmable Relay 1 (Default A1)
8	RLY1/COM	Common	
9	RLY1/NO	Normally Open	
10	RLY2/NC	Normally Closed	Programmable Relay 2 (Default A2)
11	RLY2/COM	Common	
12	RLY2/NO	Normally Open	
13	RLY3/NC	Normally Closed	Programmable Relay 3 (Default Fault)
14	RLY3/COM	Common	
15	RLY3/NO	Normally Open	

Internal Earth/
Ground Point

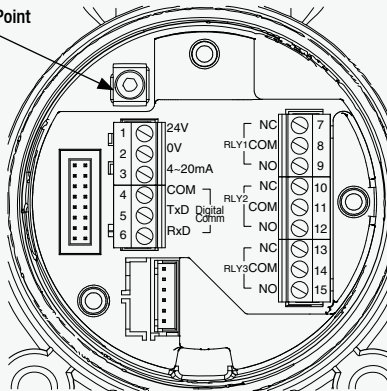

Terminal Module

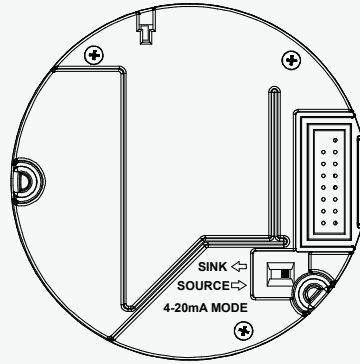

Puck Rear View

Note: Terminal Blocks are plug/socket type and may be removed to ease wiring.

Typical Cable Lengths

Typical Cable Data			Maximum Cable Length					
Cable Size (Cross Sectional Area)	Cable Resistance		Catalytic		EC		IR	
	Ω/km	Ω/mi	Metres	Feet	Metres	Feet	Metres	Feet
0.5mm ² (20AWG*)	36.8	59.2	356	1167	478	1568	420	1379
1.0mm ² (17AWG*)	19.5	31.4	671	2201	902	2956	793	2599
1.5mm ² (16AWG*)	12.7	20.4	1031	3387	1384	4549	1217	4000
2.0mm ² (14AWG*)	10.1	16.3	1296	4239	1741	5694	1531	5006
2.5mm ² (13AWG*)	8	12.9	1636	5356	2197	7194	1932	6326

Note: Table given for guidance only. Users should calculate maximum distances using actual data for cable being used. Typical calculation assumes minimum guaranteed controller supply of 24VDC, minimum detector voltage of 16VDC and maximum power supply under full alarm. R_L (max) is 250ohms.

Wiring Schematics

The Sensepoint XCD transmitter may be wired in either Current Sink or Current Source configuration. These two options are offered to allow greater flexibility in the type of control system that it can be used with. Sink/Source is selectable via the switch located on the back side of the display module; accessible by removing the display module during installation/commissioning.

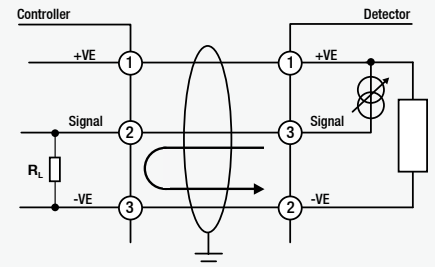

XCD Source Configuration

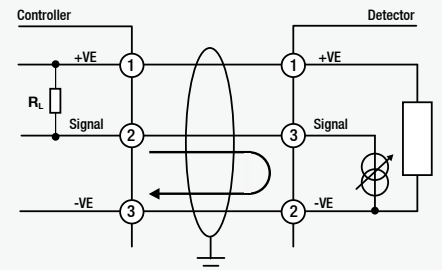

XCD Sink Configuration

Note: Terminate cable screen at the detector or the controller, not both.



Technical Summary



Sensepoint XCD Detector																																
Use	3 wire, 4-20mA and RS485 MODBUS* output fixed point detector with in-built alarm and fault relays for the protection of personnel and plant from flammable, toxic and Oxygen hazards. Incorporating a transmitter with local display and fully configurable via non-intrusive magnetic switch interface. Wide range of local and remote sensors available.																															
Electrical	<table border="0"> <tr> <td>Input Voltage Range</td> <td>16 to 32VDC (24VDC nominal)</td> </tr> <tr> <td>Max Power Consumption</td> <td>Maximum power consumption is dependent on the type of gas sensor being used. Electrochemical cells = 3.7W, IR = 3.7W and catalytic = 4.9W. Maximum inrush current = 800mA at 24VDC</td> </tr> <tr> <td>Current Output</td> <td>Sink or source</td> </tr> <tr> <td>≥0.0<1.0mA</td> <td>Fault</td> </tr> <tr> <td>2.0mA or 4.0mA (17.4mA)</td> <td>Inhibit (during configuration/user settings)</td> </tr> <tr> <td>4.0mA to 20.0mA</td> <td>Normal gas measurement</td> </tr> <tr> <td>22.0mA</td> <td>Maximum over range</td> </tr> <tr> <td>Terminals</td> <td>15 x screw terminals suitable for wire diameter 0.5mm² to 2.5mm² (20AWG to 14AWG)</td> </tr> <tr> <td>Relays</td> <td>3 x 5A@250VAC. Selectable normally open or normally closed (switch) and energised/de-energised (programmable) Alarm relays default normally open/de-energised. Fault relay default normally open/energised</td> </tr> <tr> <td>Communication</td> <td>RS485, MODBUS RTU (Pending)</td> </tr> </table>											Input Voltage Range	16 to 32VDC (24VDC nominal)	Max Power Consumption	Maximum power consumption is dependent on the type of gas sensor being used. Electrochemical cells = 3.7W, IR = 3.7W and catalytic = 4.9W. Maximum inrush current = 800mA at 24VDC	Current Output	Sink or source	≥0.0<1.0mA	Fault	2.0mA or 4.0mA (17.4mA)	Inhibit (during configuration/user settings)	4.0mA to 20.0mA	Normal gas measurement	22.0mA	Maximum over range	Terminals	15 x screw terminals suitable for wire diameter 0.5mm ² to 2.5mm ² (20AWG to 14AWG)	Relays	3 x 5A@250VAC. Selectable normally open or normally closed (switch) and energised/de-energised (programmable) Alarm relays default normally open/de-energised. Fault relay default normally open/energised	Communication	RS485, MODBUS RTU (Pending)	
Input Voltage Range	16 to 32VDC (24VDC nominal)																															
Max Power Consumption	Maximum power consumption is dependent on the type of gas sensor being used. Electrochemical cells = 3.7W, IR = 3.7W and catalytic = 4.9W. Maximum inrush current = 800mA at 24VDC																															
Current Output	Sink or source																															
≥0.0<1.0mA	Fault																															
2.0mA or 4.0mA (17.4mA)	Inhibit (during configuration/user settings)																															
4.0mA to 20.0mA	Normal gas measurement																															
22.0mA	Maximum over range																															
Terminals	15 x screw terminals suitable for wire diameter 0.5mm ² to 2.5mm ² (20AWG to 14AWG)																															
Relays	3 x 5A@250VAC. Selectable normally open or normally closed (switch) and energised/de-energised (programmable) Alarm relays default normally open/de-energised. Fault relay default normally open/energised																															
Communication	RS485, MODBUS RTU (Pending)																															
Construction	<table border="0"> <tr> <td>Material</td> <td>Housing</td> <td>Epoxy painted aluminium alloy LM25 or 316 stainless steel</td> </tr> <tr> <td></td> <td>Sensor</td> <td>316 stainless steel</td> </tr> <tr> <td></td> <td>Weather Protection</td> <td>Plastic</td> </tr> <tr> <td>Weight (approx)</td> <td>Aluminium Alloy LM25</td> <td>2.0kg (4.4lbs)</td> </tr> <tr> <td></td> <td>316 Stainless Steel</td> <td>5.0kg (11lbs)</td> </tr> <tr> <td>Mounting</td> <td colspan="2">Integral mounting plate with 4 x mounting holes suitable for M8 bolts Optional pipe mounting kit for horizontal or vertical pipe Ø1.5 to 3" (2" nominal)</td> </tr> <tr> <td>Entries</td> <td colspan="2">European ATEX/IECEx versions: 2 x M20 cable entries North American UL/cUL versions: 2 x ¾"NPT conduit entries. Suitable blanking plug supplied for use if only 1 entry used. Seal to maintain IP rating</td> </tr> </table>											Material	Housing	Epoxy painted aluminium alloy LM25 or 316 stainless steel		Sensor	316 stainless steel		Weather Protection	Plastic	Weight (approx)	Aluminium Alloy LM25	2.0kg (4.4lbs)		316 Stainless Steel	5.0kg (11lbs)	Mounting	Integral mounting plate with 4 x mounting holes suitable for M8 bolts Optional pipe mounting kit for horizontal or vertical pipe Ø1.5 to 3" (2" nominal)		Entries	European ATEX/IECEx versions: 2 x M20 cable entries North American UL/cUL versions: 2 x ¾"NPT conduit entries. Suitable blanking plug supplied for use if only 1 entry used. Seal to maintain IP rating	
Material	Housing	Epoxy painted aluminium alloy LM25 or 316 stainless steel																														
	Sensor	316 stainless steel																														
	Weather Protection	Plastic																														
Weight (approx)	Aluminium Alloy LM25	2.0kg (4.4lbs)																														
	316 Stainless Steel	5.0kg (11lbs)																														
Mounting	Integral mounting plate with 4 x mounting holes suitable for M8 bolts Optional pipe mounting kit for horizontal or vertical pipe Ø1.5 to 3" (2" nominal)																															
Entries	European ATEX/IECEx versions: 2 x M20 cable entries North American UL/cUL versions: 2 x ¾"NPT conduit entries. Suitable blanking plug supplied for use if only 1 entry used. Seal to maintain IP rating																															
Detectable Gases and XCD Sensor Performance																																
Gas	User Selectable Full Scale Range	Default Range	Steps	User Selectable Cal Gas Range	Default Cal Point	Response Time (T90) Secs	Accuracy	Operating Temperature*		Default Alarm Points																						
								Min	Max	A1	A2																					
Electrochemical Sensors																																
Oxygen	25.0%Vol. only	25.0%Vol.	n/a	20.9%Vol. (Fixed)	20.9%Vol.	<30	<+/-0.5%Vol.	-20°C / -4°F	55°C / 131°F	19.5%Vol. ▼	23.5%Vol. ▲																					
Hydrogen Sulphide	10.0 to 100.0ppm	50.0ppm	1ppm	30 to 70% of selected full scale range	25ppm	<50	<+/-1ppm	-20°C / -4°F	55°C / 131°F	10ppm ▲	20ppm ▲																					
Carbon Monoxide	100 to 1,000ppm	300ppm	100ppm		100ppm	<30	<+/-6ppm	-20°C / -4°F	55°C / 131°F	100ppm ▲	200ppm ▲																					
Hydrogen	1,000ppm only	1,000ppm	n/a		500ppm	<65	<+/-25ppm	-20°C / -4°F	55°C / 131°F	200ppm ▲	400ppm ▲																					
Catalytic Bead Sensors																																
Flammable 1 to 8*	20 to 100%LEL	100%LEL	10%LEL		50%LEL	<25	<+/-1.5%LEL	-20°C / -4°F	55°C / 131°F		20%LEL ▲	40%LEL ▲																				
Infrared Sensors																																
Methane	20 to 100%LEL	100%LEL	10%LEL		50%LEL	<40	<+/-1.5%LEL	-20°C / -4°F	50°C / 122°F		20%LEL ▲	40%LEL ▲																				
Methane*	20 to 100%Vol.	100%Vol.	10%Vol.	50%Vol.	<40	<+/-1%Vol.	-20°C / -4°F	50°C / 122°F		20%Vol. ▲	40%Vol. ▲																					
Carbon Dioxide	2.00%Vol.	2.00%Vol.	n/a	1.00%Vol.	<40	<+/-0.04%Vol.	-20°C / -4°F	50°C / 122°F		0.40%Vol. ▲	0.80%Vol. ▲																					
										▲ - Rising Alarm ▼ - Falling Alarm																						
NOTES																																
Performance data is: 1. Taken at nominal 20°C, 50%RH. 2. Applicable over the range 10 to 90% full scale. 3. Measured on units calibrated at 50% full scale. 4. Accuracy at 10% of default full scale (typical A1 alarm) of applied gas, or minimum (whichever is greater). 5. Measured at 500ml/min for IR, Toxics and O ₂ , 1 Ltr/min for Catalytic bead using the calibration cup (S3KCAL).																																
*Extended operating temperature range of -40°C to +65°C (-40°F to +149°F) for all sensors except for IR and H ₂ EC sensors, with an accuracy of +/- 30% of applied gas from -20°C to -40°C (-4°F to -40°F) and +55°C to +65°C (+131°F to +149°F). Long term operation at this range may cause decline in sensor performance. Contact Honeywell Analytics for any additional data or details.																																
Certification*																																
European International	ATEX Ex II 2 GD Ex d IIC Gb T6 (Ta -40°C to +65°C) Ex tb IIIC T85°C Db IP66																															
China	IEC Ex II 2 GD Ex d IIC Gb T6 (Ta -40°C to +65°C) Ex tb IIIC T85°C Db IP66																															
Korea	GB Ex d IIC T4 GB3836.1&2 -2000, PA, CCCF																															
US and Canada	KTL Ex d IIC T6 (-40°C to +65°C)																															
EMC	UL/cUL Class 1, Div 1, groups B,C,D																															
Performance	CE: EN50270:2006 EN6100-6-4:2007																															
	ATEX, IEC/EN60079-29-1:2007, EN45544, EN50104, EN50271																															
	China: PA Pattern Measurement (for transmitter and toxic gas sensors)																															
	"CCCF" Shenyang for Flammable (fire dept approval)																															
	UL508																															

*Contact Honeywell Analytics for availability

Technical Summary cont. and Ordering Information



Environmental	
IP Rating	IP66 in accordance with EN60529:1992
Certified Temperature Range	-40°C to +65°C (-40°F to +149°F) Note: The detector display may become illegible at temperatures below -20°C, but the detector continues its gas monitoring function. The display is not damaged and recovers when the temperature rises back above -20°C.
Operating Humidity	Continuous 20-90%RH (non-condensing), Intermittent 0-99%RH (non-condensing)
Operating Pressure	90-110kPa
Storage Conditions	-25°C to +65°C (-13°F to 131°F)
Ordering Information	
Standard Supply	Sensepoint XCD is supplied complete with integral wall mounting plate, 2 x M20 cable entry (ATEX/IECEX) or 2 x ¾"NPT conduit entries (UL/cUL), 1 x M20 or 1 x ¾"NPT plug, Allen key for locking screw, weatherproof cap, operating magnet, sensor cartridge with retainer, quick start guide and instruction manual CD. Default settings, ranges and calibrations are 100% tested at the factory. Each unit is supplied with a calibration and test certificate.
Shipping Details	Shipping carton dimensions: L312mm (12.3") x W223mm (8.8") x D110mm (4.3") Approximate weight: Aluminium 2.5kg (5.5lbs), Stainless Steel 5.5kg (12.1lbs)

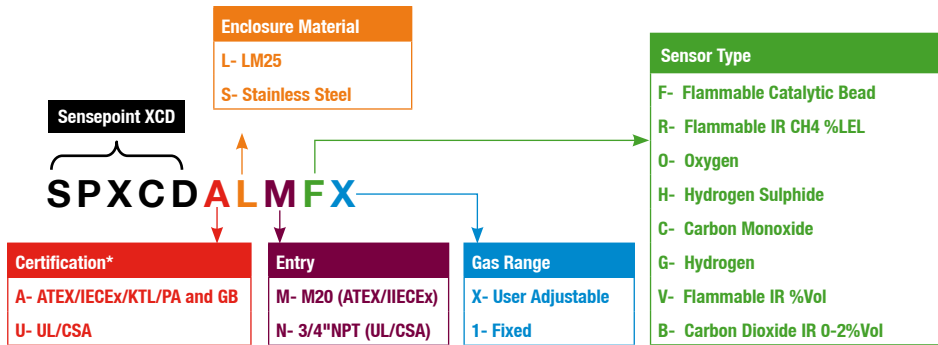

Sensepoint XCD Detector ATEX/IECEX/KTL, PA & GB (Aluminium LM25)*

SPXCDALMFX	ATEX/IECEX/KTL/PA and GB approved SP XCD Flammable CAT 0-100%LEL (20 to 100%LEL, 10%LEL) with LM25, M20 Entry
SPXCDALMRX	ATEX/IECEX/KTL/PA and GB approved SP XCD CH ₄ (Methane) IR 0-100%LEL (20 to 100%LEL, 10%LEL) with LM25, M20 Entry
SPXCDALM01	ATEX/IECEX/KTL/PA and GB approved SP XCD Oxygen 25.0%/Vol. with LM25, M20 Entry
SPXCDALMHX	ATEX/IECEX/KTL/PA and GB approved SP XCD Hydrogen Sulphide 0-50ppm (10.0 to 100.0ppm, 1ppm) with LM25, M20 Entry
SPXCDALMCX	ATEX/IECEX/KTL/PA and GB approved SP XCD Carbon Monoxide 0-300ppm (100-1000ppm, 100ppm) with LM25, M20 Entry
SPXCDALMG1	ATEX/IECEX/KTL/PA and GB approved SP XCD Hydrogen 0-1000ppm with LM25, M20 Entry
SPXCDALMV1	ATEX/IECEX/KTL/PA and GB approved SP XCD Methane IR 0-100%Vol. with LM25, M20 Entry
SPXCDALMB1	ATEX/IECEX/KTL/PA and GB approved SP XCD Carbon Dioxide IR 0-2.00%Vol. with LM25, M20 Entry

Sensepoint XCD Detector ATEX/IECEX/KTL, PA & GB (316 Stainless Steel)*

SPXCDASMF	ATEX/IECEX and AP approved SP XCD Flammable CAT 0-100%LEL (20 to 100%LEL, 10%LEL) with 316SS, M20 Entry
SPXCDASMRX	ATEX/IECEX and AP approved SP XCD CH ₄ (Methane) IR 0-100%LEL (20 to 100%LEL, 10%LEL) with 316SS, M20 Entry
SPXCDASMO1	ATEX/IECEX and AP approved SP XCD Oxygen 25.0%/Vol. with 316SS, M20 Entry
SPXCDASMHX	ATEX/IECEX and AP approved SP XCD Hydrogen Sulphide 0-50ppm (10.0 to 100.0ppm, 1ppm) with 316SS, M20 Entry
SPXCDASMCX	ATEX/IECEX and AP approved SP XCD Carbon Monoxide 0-300ppm (100-1000ppm, 100ppm) with 316SS, M20 Entry
SPXCDASMG1	ATEX/IECEX and AP approved SP XCD Hydrogen 0-1000ppm with 316SS, M20 Entry
SPXCDASMV1	ATEX/IECEX and AP approved SP XCD Methane IR 0-100%Vol. with 316SS, M20 Entry
SPXCDASMB1	ATEX/IECEX and AP approved SP XCD Carbon Dioxide IR 0-2.00%Vol. with 316SS, M20 Entry

Optional Accessories

S3KCAL	Calibration cup
SPXCDCC	Collecting cone for use with lighter than air gases
SPXCDDMK	Duct mounting kit
SPXCDHMANEN	Hard copy manual in English
SPXCDMTBR	Mounting bracket (inc. bolts, nuts, brackets)
SPXCDDSDP	Sunshade/Deluge Protection
00780-A-0100	ATEX approved junction box (Explosion-proof)

Spare XCD Sensors (316 Stainless Steel)

SPXCDXSFSS	Flammable CAT 0-100%LEL (20 to 100%LEL, 10%LEL)**
SPXCDXSRXSS	Methane IR 0-100%LEL (20 to 100%LEL, 10%LEL)**
SPXCDXS01SS	Oxygen 25.0%/Vol. only
SPXCDXSHXSS	Hydrogen Sulphide 0-50ppm (10.0 to 100.0ppm, 1ppm)**
SPXCDXSCXSS	Carbon Monoxide 0-300ppm (100-1000ppm, 100ppm)**
SPXCDXSG1SS	Hydrogen 0-1000ppm only
SPXCDXSV1SS	Methane IR 0-100%Vol. only
SPXCDXSB1SS	Carbon Dioxide IR 0-2.00%Vol. only

*For UL/CSA versions simply change the letters in the part number for certification and entry e.g. first part number in table above would become SPXCDULNFX.

**For further explanation refer to "Detectable Gases and XCD Sensor Performance" table on page 6.

Our Product Range



Fixed Gas Monitoring

Honeywell Analytics offers a wide range of fixed gas detection solutions for a diverse array of industries and applications including: Commercial properties, industrial applications, semiconductor manufacturers, energy plants and petrochemical sites.

- » Detection of flammable, oxygen and toxic gases (including exotics)
- » Innovative use of 4 core sensing technologies – paper tape, electrochemical cell, catalytic bead and infrared
- » Capability to detect down to Parts Per Billion (ppb) or Percent by Volume (%v/v)
- » Cost effective regulatory compliance solutions

Portable Gas Monitoring

When it comes to personal protection from gas hazards, Honeywell Analytics has a wide range of reliable solutions ideally suited for use in confined or enclosed spaces.

These include:

- » Detection of flammable, oxygen and toxic gases
- » Single gas personal monitors – worn by the individual
- » Multi-gas portable gas monitors – used for confined space entry and regulatory compliance
- » Multi-gas transportable monitors – used for temporary protection of area during site construction and maintenance activities

Technical Services

At Honeywell Analytics, we believe in the value of great service and customer care. Our key commitment is providing complete and total customer satisfaction. Here are just a few of the services we can offer:

- » Full technical support
- » Expert team on hand to answer questions and queries
- » Fully equipped workshops to ensure quick turnaround on repairs
- » Comprehensive service engineer network
- » Training on product use and maintenance
- » Mobile calibration service
- » Customised programmes of preventative/corrective maintenance
- » Extended warranties on products

Find out more

www.honeywellanalytics.com

Contact Honeywell Analytics:

Europe, Middle East, Africa, India

Life Safety Distribution AG
Weiherallee 11a
CH-8610 Uster
Switzerland
Tel: +41 (0)44 943 4300
Fax: +41 (0)44 943 4398
gasdetection@honeywell.com

Technical Services

EMEA: HAexpert@honeywell.com
US: ha.us.service@honeywell.com
AP: ha.ap.service@honeywell.com

www.honeywell.com

Americas

Honeywell Analytics Inc.
405 Barclay Blvd.
Lincolnshire, IL 60069
USA
Tel: +1 847 955 8200
Toll free: +1 800 538 0363
Fax: +1 847 955 8210
detectgas@honeywell.com

Asia Pacific

Honeywell Analytics Asia Pacific
#508, Kolon Science Valley (I)
187-10 Guro-Dong, Guro-Gu
Seoul, 152-050
Korea
Tel: +82 (0)2 2025 0300
Fax: +82 (0)2 2025 0329
analytics.ap@honeywell.com

Please Note:

While every effort has been made to ensure accuracy in this publication, no responsibility can be accepted for errors or omissions. Data may change, as well as legislation, and you are strongly advised to obtain copies of the most recently issued regulations, standards, and guidelines. This publication is not intended to form the basis of a contract.

H_Sensepoint XCD_V1_EMEA1

06/09

© 2009 Honeywell Analytics

Honeywell